

**Operation Manual** (EN)  
Translation of the german original manual

**Diaphragm pumps  
in casing**

**Models:**

- ▶ MPC 095 Z
- ▶ MPC 110 E



**Gardner Denver Thomas GmbH**

Am Vogelherd 20

98693 Ilmenau

Germany

T +49 3677 604 0

F +49 3677 604 131

[welch.emea@gardnerdenver.com](mailto:welch.emea@gardnerdenver.com)

[www.welchvacuum.com](http://www.welchvacuum.com)

Customer Support +49 3677 604 0

We are constantly working on the further development of all our product models. Reprinting or reproduction of this manual, including extracts, is not allowed without the prior written permission of Co. Gardner Denver Thomas GmbH.

All rights under the copyright laws are expressly reserved by Co. Gardner Denver Thomas GmbH.

We reserve the right to make changes and amendments.

**Contents**

<b>1</b>	<b>Important Information</b> .....	<b>4</b>
1.1	General Information .....	4
1.2	Target Groups .....	4
1.3	Intended Use.....	4
1.4	Use for an Unauthorized Purpose .....	4
1.5	Safety Devices .....	5
1.6	Meaning of the Warning notes .....	5
1.7	Product Standards, Safety Regulations .....	5
<b>2</b>	<b>Basic Safety Instructions</b> .....	<b>6</b>
2.1	General Information .....	6
2.2	Electricity.....	6
2.3	Mechanical Systems .....	6
2.4	Hazardous Substances.....	7
2.5	High Temperatures .....	7
<b>3</b>	<b>Description</b> .....	<b>8</b>
3.1	Design .....	8
3.2	Areas of Application .....	8
3.3	Pump head circuitry .....	9
3.4	Materials of the medium-affecting pump parts.....	9
3.5	Scope of Delivery .....	9
3.6	Accessories (optional).....	9
<b>4</b>	<b>Technical Data</b> .....	<b>11</b>
4.1	Dimensional drawings.....	11
4.2	Intake Pressure / Pumping Speed – Diagram .....	11
4.3	Device Data.....	12
<b>5</b>	<b>Installation and Operation</b> .....	<b>13</b>
5.1	Unpacking .....	13
5.2	Installation and Connection.....	13
5.3	Operation .....	14
5.4	Storage.....	14
5.5	Scrap Disposal .....	14
<b>6</b>	<b>Maintenance and Servicing</b> .....	<b>15</b>
6.1	General Requirements.....	15
6.2	Maintenance Performed by the User .....	15
6.2.1	Disassembly.....	16
6.2.2	Assembly.....	16
6.2.3	Test .....	17
6.3	Maintenance by the Manufacturer .....	17
6.4	Damage Report.....	17
<b>7</b>	<b>Troubleshooting</b> .....	<b>18</b>
<b>8</b>	<b>Spare Parts Overview</b> .....	<b>19</b>
8.1	Service kit.....	19
8.2	Spare parts view .....	20
8.2.1	Spare parts list .....	21

**EC Declaration of Conformity**

# Important Information

## 1 Important Information

### 1.1 General Information

The Diaphragm Pumps conform to the following directives:

2006 / 42 / EC	Machinery Directive
2014 / 30 / EU	Electromagnetic Compatibility Directive

The CE sign is located on the rating plate. Observe the binding national and local regulations when fitting the pump into installations!

Our products are sold worldwide and can therefore be equipped with the typical national plugs and for the various voltages. You will find more information about the available pump designs on our web page in the internet.

### 1.2 Target Groups

This Operating Manual is intended for the personnel planning, operating and maintaining Diaphragm Pumps.

This group of people includes:

- Designers and fitters of vacuum apparatus,
- Employees working on commercial laboratory and industrial vacuum technology applications and
- Service personnel for diaphragm pumps

The personnel operating and maintaining the diaphragm pumps must have the technical competence required to perform the work that has to be done. The user must authorize the operating personnel to do the work that has to be done. The personnel must have read and understood the complete Operating Manual before using the diaphragm pumps. The Operating Manual must be kept at the place of use and be available to the personnel when required.

### 1.3 Intended Use

- The layout of the diaphragm pump must be appropriate for the conditions of use. The user bears the sole responsibility for this.
- The diaphragm pump may only be operated under the conditions stated
  - in the "Technical Data" section,
  - on the type plate, and
  - in the technical specification for the order concerned.
- Diaphragm pumps are approved for extracting, pumping and compressing gases and vapours. If these gases and vapours are toxic or explosive, then the user must observe the currently valid safety regulations for this application. Special types of diaphragm pumps are available for aggressive and explosive gas mixtures.

### 1.4 Use for an Unauthorized Purpose

It is forbidden to use the pump for applications deviating from the technical data stated on the type plate or the conditions stated in the supply contract, or to operate it with missing or defective protective devices.

## 1.5 Safety Devices

Measures such as the following are for the safety of the operating personnel:

- electrical connection with a protective conductor (operating mode S1)
- Main switch
- Device fuse
- "Hot Surface" label on the pump body - warning notice 

The diaphragm pump must not be operated without these elements.

## 1.6 Meaning of the Warning notes

Take note of the warning notices. They are in the following box:

	<b>CAUTION ! / WARNING !</b>
<b>Hazard which may lead to serious injuries or material damage.</b>	

## 1.7 Product Standards, Safety Regulations

Diaphragm Pumps meet the following product standards:

<b>DIN EN ISO 12100:2011-03</b>	Safety of machinery - General principles for design - Risk assessment and risk reduction
<b>DIN EN ISO 13857:2008-06</b>	Safety of machinery - Safety distances to prevent hazard zones being reached by upper and lower limbs
<b>DIN EN 1012-2:2011-12</b>	Compressors and vacuum pumps - Safety requirements - Part 2: Vacuum pumps
<b>DIN EN ISO 2151:2009-01</b>	Acoustics - Noise test code for compressors and vacuum pumps - Engineering method (grade 2)
<b>DIN EN 60204-1:2014-10</b>	Safety of machinery - Electrical equipment of machines - Part 1: General requirements
<b>DIN EN 61000-6-2:2011-06</b> <b>DIN EN 61000-6-4:2011-09</b>	Electromagnetic compatibility (EMC) - Part 6-2: Generic standards - Immunity for industrial environments Part 6-4: Generic standards - Emission standard for industrial environments
<b>DIN EN 61010-1/A1:2015-04</b>	Safety requirements for electrical equipment for measurement, control and laboratory use - Part 1: General requirements
<b>DIN EN 50110-1:2014-02</b>	Operation of electrical installations
<b>Directive 2012/19/EU</b>	Electrical and electronics - old devices (WEEE)
<b>Directive 2011/65/EU</b>	Dangerous materials in electrical and electronics devices (RoHS II)
<b>China - RoHS II</b>	Environment protection law - China 2016-01

The following additional safety regulations apply in the FR Germany:

<b>DGUV Regulation 1</b>	Accident prevention regulations, principles of prevention
<b>DGUV Regulation 3</b>	Safety and testing of electrical equipment and equipment
<b>DGUV Rule 100-500</b>	Operation of work equipment
<b>DGUV Information 213-850</b>	Safe working in laboratories

Observe the standards and regulations applying in your country when you use the diaphragm pumps.

# Basic Safety Instructions

## 2 Basic Safety Instructions

### 2.1 General Information

Warning notices must be observed. Disregarding them may lead to damage to health and property.

The diaphragm pumps must be operated by personnel who can detect impending dangers and take action to prevent them from materialising.

The manufacturer or authorized authorised workshops will only service or maintain the diaphragm pump if it is accompanied by a fully completed damage report. Precise information about the contamination (also negative information if necessary) and thorough cleaning of the diaphragm pump are legally binding parts of the contract.

Contaminated diaphragm pumps and their individual parts must be disposed of in accordance with the legal regulations.

The local regulations apply in foreign countries.

### 2.2 Electricity

The diaphragm pumps of operation mode S1 are supplied. When the location of operation mode S1 devices is changed, please note that the testing must be repeated in accordance with DIN EN 0105, DIN EN 0702 and DGUV Regulation 3. . The local regulations apply in foreign countries.

Please note the following when connecting to the electrical power supply system:

- The electrical power supply system must have a protective connector according to DIN IEC 60364-4-41.
- The protective connector must not have any breaks.
- The connecting cable must not be damaged.

### 2.3 Mechanical Systems

Improper use can lead to injuries or material damage. Observe the following instructions:

- Only operate the diaphragm pumps with hoses of the specified dimensions.
- The maximum permissible pressure of 1 bar at the suction connection must not be exceeded.
- Hazardous substances must be separated out as far as this is technically possible before they reach the pump.
- External mechanical stresses and vibrations must not be transmitted to the pump. Only use flexible NW 8 laboratory hoses for connecting diaphragm pumps.
- The overpressure generated at the pressure port must not exceed 1 bar.
- The pump must not be used to suck up fluids. Lay the exhaust pipe so that it slopes downwards, so allowing condensate to flow out of the pump. Collect the condensate and dispose of it in an environmentally compatible manner.
- Prevent dyes exuding.
- Maintain near the venting slots a space of least 20 mm between the pump and adjacent parts in order to enable the pump to cool.

	<b>CAUTION !</b>
<b>Solid particles in the pumping medium impair the pumping action and can lead to damage. Prevent solid particles penetrating into the pump.</b>	

## 2.4 Hazardous Substances

The operating company bears the responsibility for the use of the diaphragm pump. Hazardous substances in the gases to be pumped can cause personal injuries and property damage. Pay attention to the warning notices for handling hazardous substances. The local regulations apply in foreign countries.

### Combustible Gases

Examine before switching on whether that can form gas combustible gas/air mixtures which can be promoted! Consider the regulations of the guideline 1999/92/EC.

### Explosive gases

The diaphragm pumps are not certified according to ATEX guidelines 2014/34/EU.

### Aggressive gases

The MPC series is designed for extracting contaminated gases!

Especially aggressive gases have to be explicitly checked for material resistance as described *in chapter 3.5* and, if necessary, modified.

### Poisonous gases

Use a separator when pumping poisonous or harmful gases. Prevent such substances from leaking out of the appliance or pump. Treat these substances according to the applicable environmental protection regulations.

Test the strength and leak-tightness of the connecting lines and the connected apparatus. Prevent environmental poisons, e.g. mercury, getting into the diaphragm pumps.

Fulfil the requirements, for example:

- German Hazardous Substances Regulation (GefStoffV) of 01. December 2010
- Regulations 2016/1179/EU (classification, packaging and identification of hazardous sub-stances),
- Manufacturer's safety data sheets on hazardous substances.

## 2.5 High Temperatures

The diaphragm pump may heat up as a result of the temperature of the gas being pumped and through compression heat.

Prevent the following maximum permissible temperatures from being exceeded + 40 °C for the environment and the gas to be pumped.

The motor for single phase alternating current is protected against overload by a fine-wire fuse.

# Description

## 3 Description

### 3.1 Design

Model	MPC 095 Z	MPC 110 E
Order no.	412422-02	412421-02
<b>Legend:</b>		
(1)	Intake connection	
(2)	Exhaust connection	
(3)	Non-heating apparatus	
(5)	ON/OFF	
Electrical connection via:	Input voltage 90 – 260V, 50/60Hz	
Device fuse	automatic via an external power pack	
Improvement of water vapor compatibility is possible, via:	a gas ballast valve on the front page	
Design	<p>When condensable vapours are pumped, they may be compressed above the saturated vapour pressure and condense. Opening the gas ballast valve in the suction line allows air to flow into the pump chamber. This prevents condensation and flushes the pump clear.</p> <p>The diaphragm pump consists of a pump body and a drive motor in casing. The pump body consists of an eccentric shaft, two connecting rod and two pump heads. Each pump head contains a diaphragm and two work valves. The pump heads are arranged in 180° opposite each other.</p> <p>The pump heads are driven via the motor and the eccentric shaft with a connecting rod.</p> <p>The suction connection (1) and the exhaust connection (2) are located directly on the pump head and are designed as hose nozzle for an inside hose diameter of 8 mm.</p>	
Function	<p>Motor, eccentric shaft and connecting rod set the diaphragms in stroke movement. This changes the size of the space between the diaphragms and pump head (pump chamber).</p> <p>Increasing the size of the pump chamber opens the inlet valve while the outlet valve is closed (gases are sucked in).</p> <p>Decreasing the size of the pump chamber switches the valves over and ejects the gas through the exhaust outlet.</p> <p>The valves are actuated by the gas being pumped. A large proportion of condensate in the diaphragm pump minimizes the suction performance and the ultimate pressure that can be achieved.</p>	

### 3.2 Areas of Application

#### The Diaphragm pumps are intended for:

Pumping and compressing neutral and aggressive gases and vapours.

- Generating a vacuum down to an ultimate pressure < 5 mbar.
- Use in physical and chemical laboratories in trade and industry.
- Use for vacuum filtration, vacuum distillation and vacuum drying, and other vacuum technology applications.
- These can also be used in stripped down form for OEM applications (for example without a casing).



## 3.3 Pump head circuitry

<b>One-stage (E):</b>	Both pump heads are connected in parallel.
Ultimate pressure:	< 50 mbar
Model:	MPC 110 E
<b>Two-stage (Z):</b>	Both pump heads are connected in series.
Ultimate pressure:	< 5 mbar
Model:	MPC 095 Z

## 3.4 Materials of the medium-affecting pump parts



Component	Material Chemical model, <i>resistant to aggressive gases</i>
Seal	EPDM
Screw fitting / Connecting element	PVDF, PP
Valve	PEEK
Diaphragm	fabric reinforced with a PTFE layer foil
Vacuum hose	PTFE
Connection head / Pump head	PTFE with carbon-fibre reinforcing <sup>*)</sup>

<sup>\*)</sup> electrically conductive (with manufacturer's certificate of electrical conductivity)  
Material resistance to aggressive media see: Publisher Hoppenstedt Publishing (18. September 2007)





## 3.5 Scope of Delivery

The scope of delivery is specified in the supply contract.

## 3.6 Accessories (optional)

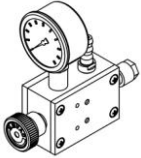
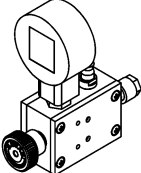
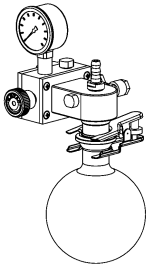
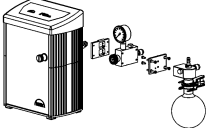
Figure	Designation / Usage	Order no.
	<b>Vacuum Control-Box</b> Type: VCB 521 cv  for measuring and regulation of vacuum	<b>600053</b>
	<b>Operating software "WELCH-Control 521"</b> on CD with Dual-Data Cable  to connect to the PC	<b>620637-01</b>
	<b>Vacuum hose rubber, 18 / 8x5 mm</b>  1.5 m	<b>828310-4</b>

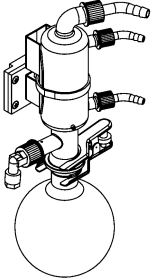
## Description

Figure	Designation / Usage	Order no.
 	<p><b>Vacuum regulator with dial gauge (analog) Model: DBR – P</b></p> <p><b>Vacuum regulator with dial gauge (digital) Model: DBR – P</b></p> <p>With the help of this dosing block it is possible to regulate the final pressure of the pump. You can see the actual pressure at the dial gauge (manometer).</p> <p>For mounting of diaphragm pump. Mounting: Clamping connection over nut of the side profiles</p>	<p><b>700459</b></p> <p><b>700459-01</b></p>
 	<p><b>Vacuum regulator with dial gauge + Separator</b> <b>Type: DBR – PS</b></p> <p>With the help of this dosing block it is possible to regulate the final pressure of the pump. You can see the actual pressure at the dial gauge (manometer).</p> <p>For mounting of diaphragm pump. Mounting: Clamping connection over nut of the side profiles</p>	<p><b>700461</b></p>
	<p><b>Set of Extension: Separator 500 ml</b></p> <p>For mounting of diaphragm pump. Mounting: Clamping connection over nut of the side profiles</p>	<p><b>700460</b></p>
	<p><b>Set of Extension: Emission condenser 500 ml</b></p> <p>For mounting of diaphragm pump. Mounting: Clamping connection over nut of the side profiles</p>	<p><b>700462</b></p>
	<p><b>Mains connection cable IEC with plug type 12 (CH)</b></p> <p>for diaphragm pumps ... in 230 V</p>	<p><b>825877</b></p>

## 4 Technical Data

### 4.1 Dimensional drawings

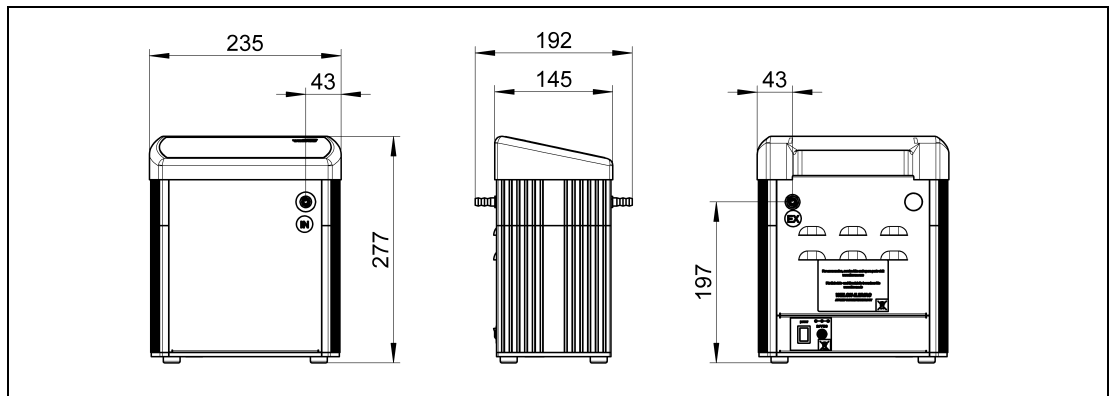

Fig. 1a Dimensional drawing MPC 110 E

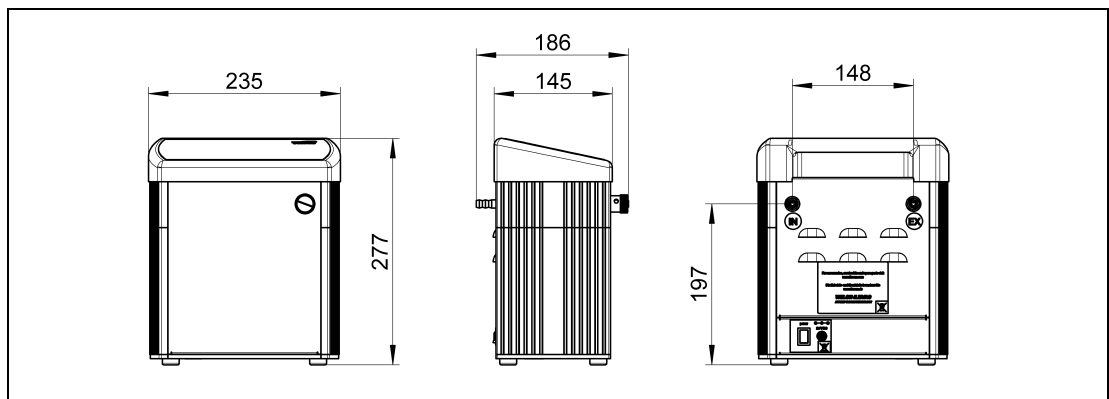

Fig. 1b Dimensional drawing MPC 095 Z

### 4.2 Intake Pressure / Pumping Speed – Diagram

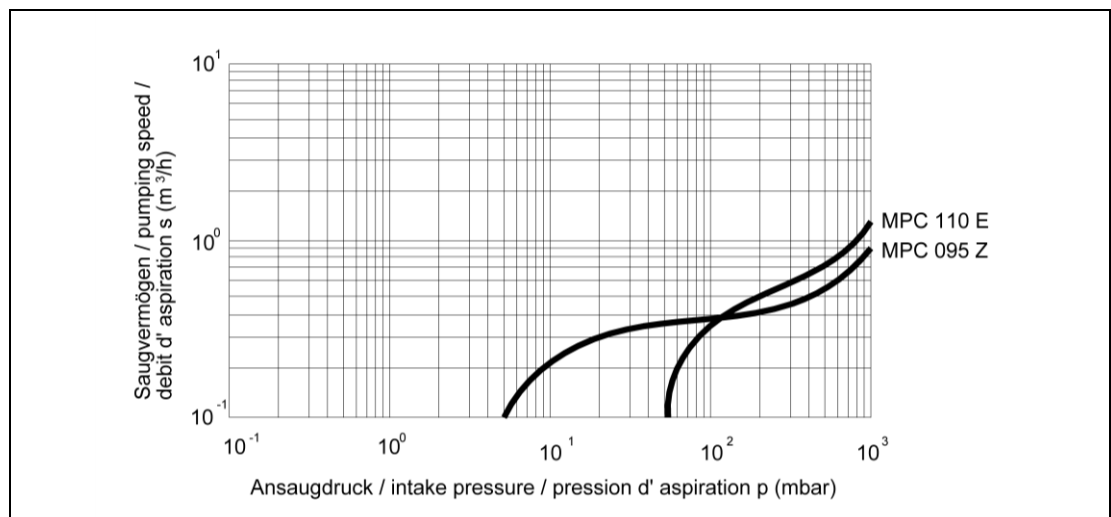

Fig. 2 Intake Pressure / Pumping Speed – Diagram

# Technical Data

## 4.3 Device Data

Parameter	Unit	MPC 095 Z	MPC 110 E
<b>Pumping speed 50/60 Hz</b> DIN 28432 (at speed of 3000 rpm)	m <sup>3</sup> / h	0.9	1.2
	l / min	15	20
<b>Ultimate pressure</b> (at speed of 3000 rpm)	mbar	5	50
<b>Max. inlet pressure</b>	bar	1	
<b>Max. outlet pressure</b>		unpressurised	
<b>Intake- / Exhaust port</b>	-	Hose nozzle DN 8 for hose inside diameter 8 mm	
<b>Ambient temperature</b>	°C	+ 10 to + 40	
<b>Max. Operating gas temperature</b>		+ 40	
<b>Bearing</b>	-	maintenance-free	
<b>Reference surface sound pressure level</b> DIN EN ISO 2151	dB (A)	< 45	
<b>Voltage, Frequency</b>	V DC	24	
	V AC, Hz	90...260, 50/60 power pack extern	
<b>Rated current</b>	A	1.2 (24V DC)	
	W	20 (230V AC)	
<b>Operating mode</b>	-	S 1	
<b>Type of protection</b> DIN EN 60529		IP 44	
<b>Motor / Class of insulation</b> DIN EN 600034-1		F (160°C)	
<b>Weight</b>	kg	6.15	
<b>Dimensions (W/D/H)</b>	mm	235 / 189 / 277	235 / 192 / 277
<b>Order number for:</b>	-		
<b>Diaphragm pump</b> <i>inclusive</i> <i>mains connection cable</i> <i>with plug CEE, UK, US</i>		412422-02	412421-02

The information presented in this material is based on technical data and test results of nominal units. It is believed to be accurate and reliable and is offered as an aid to help in the selection of products. It is the responsibility of the user to determine the suitability of the product for the intended use and the user assumes all risk and liability whatsoever in connection therewith. Gardner Denver Thomas GmbH does not warrant, guarantee or assume any obligation or liability in connection with this information.

## 5 Installation and Operation

### 5.1 Unpacking

Carefully unpack the diaphragm pump.

Check the pump for:

- Transport damage,
- Conformity with the specifications of the supply contract (type, electrical supply data),
- Completeness of the delivery.

Please inform us without delay if there are discrepancies between the delivery and the contractually agreed scope of delivery, or if damage is detected.

Please take note of the general terms of business of the manufacturing firm.

**In case of a claim under warranty, the device must be returned in packaging that is suitable for protecting it during transport.**

### 5.2 Installation and Connection

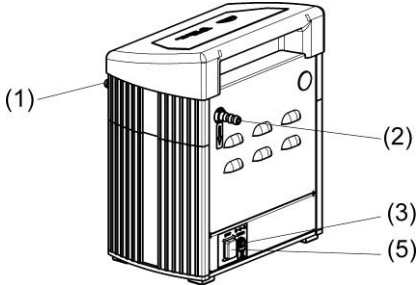
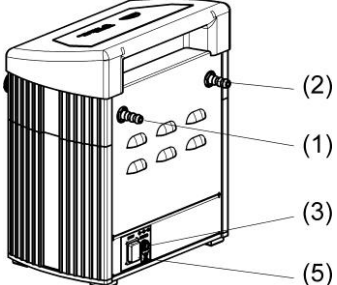
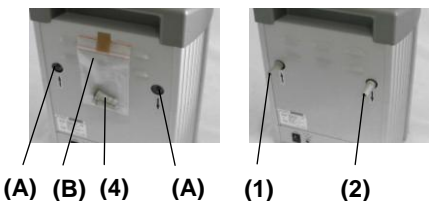
MPC 110 E	MPC 095 Z
90...260 V AC / 24 V DC	90...260 V AC / 24 V DC
	
<p>- Set the diaphragm pump on a flat and horizontal surface.</p>	
<p>- Take the two identically constructed hose nozzles <b>(4)</b> (complete with O-ring) out of the bag <b>(B)</b> fastened to the diaphragm pump for supply.</p> <p>- Screw the hose nozzles as intake - <b>(1)</b> and/or pressure connection <b>(2)</b> into the thread seats <b>(A)</b> planned for it, <i>sample see figures right.</i></p>	<p><i>as-delivered condition:</i>      <i>after the assembly:</i></p> 
<p>- Connect the NW 8 vacuum connector to the suction port <b>(1)</b>.</p>	
<p>- Connect the diaphragm pump with the made available switch power pack and the electrical supply <b>(3)</b>.</p>	
<p>- The diaphragm pump is switched on and off at the ON/OFF-switch <b>(5)</b>.</p>	

# Installation and Operation

## 5.3 Operation

	<b>CAUTION !</b>
<b>Observe the basic safety instructions when using the pump.</b>	

## 5.4 Storage

The pumps are to be stored in a low-dust, interior room within the temperature range from + 5 to + 40 °C and at a relative air humidity < 90%.

Leave the protective elements on the suction and pressure ports. Another equally good protection may be used. The interior of the pump heads must be dry and free of condensates.

The interior of the pump heads must be dry and free of condensates.

## 5.5 Scrap Disposal

	<b>CAUTION !</b>
<b>The Diaphragm pumps must be disposed of in accordance with the 2012/19/EU guideline and the specific national regulations. Contaminated diaphragm pumps must be decontaminated according to the laws.</b>	

## 6 Maintenance and Servicing

### 6.1 General Requirements

- Check the pump daily for unusual running noises and heat building up on the surface of the pump.
- We recommend changing the diaphragm after 10,000 operating hours. The user may specify that the exchange be made earlier, depending upon the application process.
- Check the electrical and vacuum connections daily.

### 6.2 Maintenance Performed by the User

	<b>WARNING !</b>
<p>Only perform the work that is described here, and that which is permitted to be done by the user. All other maintenance and service work may only be performed by the manufacturer or a dealer authorized by him. Beware of the pump parts being possibly contaminated by hazardous substances. Wear protective clothing if there is contamination.</p>	

#### Scope of permissible work:

- Inspect the pump chambers, diaphragms and valves,
- Deposits in the inside of the pump must be cleaned out,
- Change the diaphragms, valves and seals.

	<b>WARNING !</b>
<p>Before opening the pump unplug it from the mains.</p>	

#### Tools required:

**Tool kit: Order no. 402107, consists of:**

- Order no. 826801-4      Cross-head screwdriver, size 2,
- Order no. 826801-2      Open spanner, size SW 14.

# Maintenance and Servicing

## 6.2.1 Disassembly

1. Disconnect the power supply and ensure that it cannot be switched on again.
2. Open the cover of the casing.
3. Open the screw clamps of the hose bridge on the pump body with the open spanner, size 14.
4. Remove 2 x 4 screws **(1)** from each connecting head **(2)** with a cross-head screwdriver, size 2.
5. Lift off the connecting head **(2)** and the pump head **(5)**. The diaphragm is now freely exposed.
6. Loosen the defective diaphragm **(6)** by turning it anticlockwise.
7. Valves **(4)** and o-rings **(3)** are located between the connecting and the pump head. When dismantling both heads these parts are accessible.
8. Clean the valves **(4)**, o-rings **(3)** and diaphragm **(6)** with a soft cloth and acetone and replace defective items if necessary.

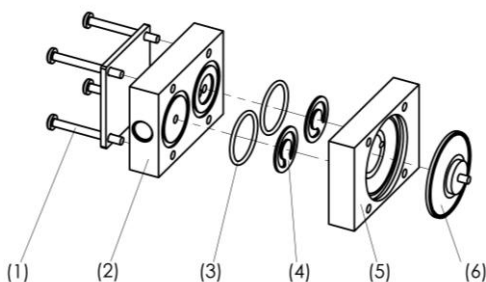



Fig. 3 Disassembly - Assembly

	<b>WARNING !</b>
<p><b>Renew defective parts, if necessary! Wear protective gloves!</b> <b>Parts must be renewed at the intervals stated in this Operating Manual or as specified by the user internally!</b> <b>Do not clean with compressed air!</b></p>	

## 6.2.2 Assembly (see Fig. 3)

1. Place the pump so that the diaphragm **(6)** is lying in a horizontal position.
2. Tighten the diaphragm **(6)** with the torque of 5 - 6 Nm.
3. Bring the connecting rod (see Fig. 4) and the diaphragm **(6)** into the central position.
4. Replace the pump head **(5)**.
5. Insert the valves **(4)** and the o-rings **(3)**. Ensure that they are lying completely flat. Do not insert the burred side facing the sealing surface.
6. Replace the connecting head **(2)** and tighten the 2 x 4 cross head screws **(1)** with a torque of 3 - 4 Nm.
7. Use an analogue assembly sequence for all heads.
8. Reattach the hose connections with clamping ring screw fittings.
9. Close the casing by shutting the cover.



## 6.2.3 Test

- Connect the pump to the electrical supply.
- Connect a vacuum measuring device to the suction connector and measure the ultimate pressure.  
If the device is working properly, then the figure stated in the technical data must be attained within a maximum of one minute.
- The pump must not make any abnormal noises.
- Moving parts must not touch each other.

## 6.3 Maintenance by the Manufacturer

Repairs and maintenance going beyond the extent of the work described *in chapter 6.2* or reconditioning or modification may only be performed by the manufacturer or authorized workshops.

	<b>CAUTION !</b>
<b>The user shall be liable for the consequences of an incorrect damage report or a contaminated pump. The statements in the damage report are legally binding.</b>	

## 6.4 Damage Report

You find the form of the damage report to the Download on our web page in the menu "service" and "Downloads". [www.welchvacuum.com](http://www.welchvacuum.com)

If you should not have an entrance to the Internet, you can request the form also gladly with us, under phone +49 3677 604 0.

	<b>CAUTION !</b>
<b>Incomplete or incorrectly completed damage reports may endanger the service personnel!</b> <b>Give full information in the damage report, in particular regarding a possible contaminating of the pump.</b>	

# Troubleshooting

## 7 Troubleshooting

Only manufacturing firm and authorized service workshops may work on the diaphragm pump and their accessories during the warranty period.

Trouble	Cause	Remedy	
		by:	with:
Vacuum pump does not start	No power supply	<b>Qualified electrician</b>	Check electrical installation
	Motor defective	<b>Service workshop</b>	Exchange
	Pump body defective		Repair and/or exchange
Vacuum pump does not generate a vacuum or only an inadequate one	Connected apparatus and/or connecting elements leaking	<b>User or Service workshop</b>	Identify and seal the leak, replace the seals and/or hoses if necessary.
	Vacuum pump leaking		Check the hose connections between the pump heads, replace the hoses and/or fittings if necessary.
	Pump head leaking	<b>Service workshop</b>	Repair and/or exchange
	Diaphragm defective	<b>User or Service workshop</b>	Exchange of the diaphragm (see chapter 6.2)
	Valve defective		Exchange of the valve (see chapter 6.2)
	Vacuum pump dirty		General maintenance / cleaning
	Valves dirty		Cleaning condensates and foreign objects out of the valves.
Running noise	Vacuum pump dirty	<b>User or Service workshop</b>	General maintenance / cleaning
Cable(s)	defective and/or brittle	<b>Qualified electrician</b>	Exchange of the cable(s)

## 8 Spare Parts Overview

The spare parts lists contain all the spare parts and all the information necessary for ordering.

When ordering, please quote the description, quantity, serial number and order number!

	<b>CAUTION !</b>
<b>We are not liable for any damage caused by the installation of any parts not supplied by the manufacturer.</b>	

### 8.1 Service kit

Designation	Order no.
Service kit	402045

The service kit consists of:

Designation	Piece
O-Ring $\varnothing$ 25 x 2	4
O-Ring $\varnothing$ 8 x 2	6
Valve	4
Form diaphragm	2

**Caution, the number of supplied construction units in the service kit corresponds to the maximum need of the series!**

# Spare Parts Overview

## 8.2 Spare parts view

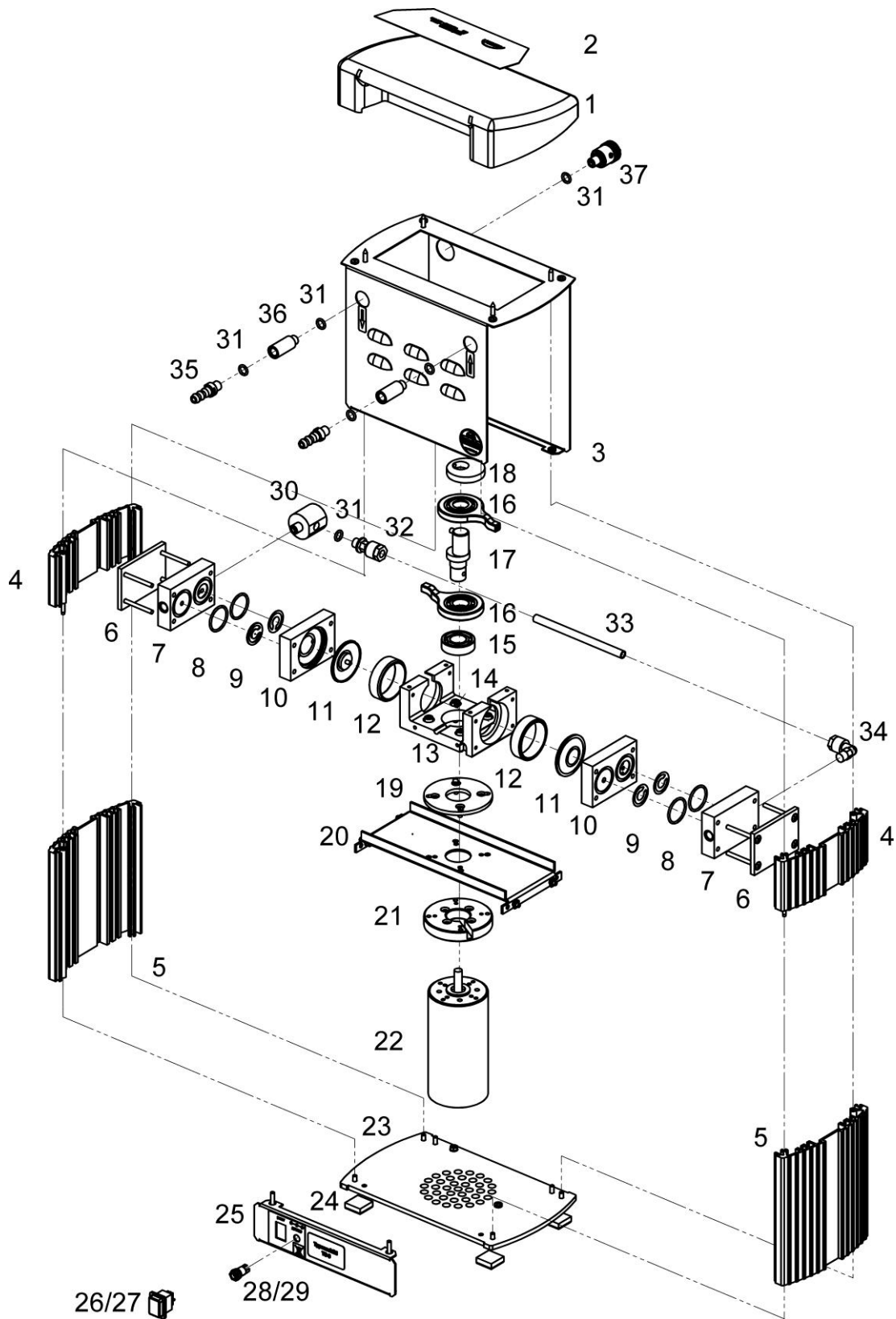



Fig. 4 Exploded view (MPC 095 Z)

## 8.2.1 Spare parts list

Item no.	Designation	Piece	MPC 110 E	MPC 095 Z
			Order no. 412421-02	Order no. 412422-02
			Order no.	Order no.
1	Casing cover	1	410216	410216
2	Front foil	1	828906-03	828906-03
3	Casing	1	410213	410213
4	Aluminium profile (60 mm long)	2	400979-06	400979-06
5	Aluminium profile (155 mm long)	2	400979	400979
6	Pressure plate	2	400935	400935
7	Connection head	2	400899-04	400899-04
8	O-Ring EPDM Ø 25 x 2	4	829250-1	829250-1
9	Valve	4	400656	400656
10	Pump head	2	400898-02	400898-02
-	Basic pump complete <i>(consisting of pos. 11 – 22)</i>	1	410201-05	410201-05
11	Form diaphragm	2	828929-1	828929-1
12	Cylinder	2	400914	400914
13	Pump casing	1	400944	400944
14	Rubber element	4	400916	400916
-	Drive complete <i>(consisting of pos. 15 – 18)</i>	2	400859-01	400859-01
15	Ball bearing	1	824963-1	824963-1
16	Piston rod with ball bearing	1	400892-01	400892-01
17	Eccentric	1	400915-07	400915-07
18	Mass balance	1	400945-01	400945-01
19	Insulating washer	1	400893-04	400893-04
20	Intermediate plate	1	410215	410215
21	Distance ring for motor	1	400923-01	400923-01
22	Motor	1	826468	826468
23	Foot plate	1	410210	410210
24	Casing foot	4	829112	829112
25	Switch sheet metal	1	410214-01	410214-01
26	Rocker switch green	1	825186-3	825186-3
27	Protection cap for rocker switch	1	825188-1	825188-1
28	Panel jack	1	825253	825253
29	Power pack	1	827406	827406
30	Manifold PP, G1/8" – 2x G1/8" L	2	400921	400921
31	O-Ring EPDM Ø 8 x 2	4	829210-3	-
		6	-	829210-3
32	Straight threaded joint with seal edge PVDF, 8 - 1/8"	2	829919	-
		1	-	829919
33	Vacuum hose PTFE, 8 / 6x1 mm	0.3 m	828331	-
		0.2 m	-	828331
34	Threaded elbow joint PVDF, 8 – 1/8"	2	829936-1	829936-1
35	Hose nozzle PP, DN 8 – 1/8"	2	710797	710797
36	Extension PP, G1/8" – 1/8"	1	-	400779-5
37	Gas ballast valve	1	-	400599-04
-	Mains connection cable IEC with plug CEE (D)	1	825885	825885
	Mains connection cable IEC with plug BS (UK)	1	825878	825878
	Mains connection cable IEC with plug NEMA 5-15 (US)	1	825903	825903

# EG - Konformitätserklärung

## EC Declaration of Conformity / CE Déclaration de Conformité

<b>DE:</b>  Hiermit erklären wir	 by Gardner Denver	<b>Gardner Denver Thomas GmbH</b> Am Vogelherd 20 98693 Ilmenau Germany	T +49 3677 604 0 F +49 3677 604 131 <a href="mailto:welch.emea@gardnerdenver.com">welch.emea@gardnerdenver.com</a> <a href="http://www.welchvacuum.com">www.welchvacuum.com</a>
--	--	--	--

unter eigener Verantwortung, dass nachstehendes Produkt aufgrund seiner Konzipierung und Bauart sowie in den von uns in Verkehr gebrachten Unterlagen den nachfolgend aufgeführten EG-Richtlinien und Normen entspricht.  
 Bei einer nicht mit uns abgestimmten Änderung des Produkts verliert diese Erklärung ihre Gültigkeit.

**EN:** We (Gardner Denver Thomas GmbH) herewith declare under our sole responsibility that the product described below is in accordance with the following Directives standards and other technical specifications regarding design and version when delivered from our factory.  
 This declaration becomes invalid whenever the product has been modified without our consent.

**FR:** Nous (Gardner Denver Thomas GmbH) certifions par la présente, que le produit décrit ci-après est conforme, tant dans sa conception que dans sa réalisation, aux normes de sécurité et d'hygiène exigées par les standards de la CE.  
 En cas de modification du produit sans notre accord, cette déclaration devient caduque.

<b>Bezeichnung des Produkts (Pumpen / Pumpstände)</b> Description of product (pumps / pump systems) <i>Description du produit (pompes / pompe systèmes)</i>	<b>Membranpumpe / Diaphragm pump / Pompe à membrane</b> <b>MPC 095 Z, MPC 105 E</b>
<b>Artikel-Nr. / Fabrication No. / No. de fabrication</b>	412422-02, 412421-02, 412421-06, 412422-10

**Das Produkt entspricht folgenden Richtlinien und Normen:** / The product is in conformity with the following Directives and standards: / *Le produit est conforme aux directives et standards suivants:*

<b>X</b>	<b>2006/42/EG</b>	<b>Maschinenrichtlinie / EC machinery directive / directive CE sur les machines (17.05.2006)</b>
	<b>2014/34/EU</b>	<b>ATEX-Richtlinie für Verwendungen in explosionsgefährdeten Bereichen, Anhang III / ATEX Guideline for use in potentially explosive atmospheres, Appendix III / ATEX Directive for applications in hazardous areas, Annex III</b>
<b>X</b>	<b>2014/30/EU</b>	<b>Elektromagnetische Verträglichkeit / EC Electromagnetic Compatibility Directive / Directive CE relative à la compatibilité électromagnétique</b>
<b>X</b>	<b>2011/65/EU</b>	<b>Gefährliche Stoffe in Elektro- und Elektronikgeräten (RoHS II) / Dangerous materials in electrical and electronics devices (RoHS II) / Substances dangereuses dans les appareils électriques et électroniques (RoHS II)</b>
<b>X</b>	<b>2012/19/EU</b>	<b>Elektro- und Elektronik - Altgeräte (WEEE) / Electrical and electronics - old devices (WEEE) / Electro et électronique - appareils de contralto (WEEE)</b>
<b>X</b>	<b>China – RoHS II</b>	<b>Umweltschutzgesetz – China 2016-01 / Environment protection law / Loi sur la protection de environnement</b>

**Angewandte harmonisierte Normen:** / Applied harmonized standards: / *Standards appliqués et harmonisés:*

	<b>DIN EN 1127-1: 2011-10</b>	<b>Explosionsfähige Atmosphären – Explosionsschutz - Teil 1: Grundlagen und Methodik / Explosive atmospheres - Explosion prevention and protection - part 1: Basic concepts and methodology / Atmosphères explosives - Protection contre les explosions - partie 1 : prescriptions et méthodologie</b>
	<b>DIN EN 13463-1: 2009-07</b>	<b>Nicht-elektrische Geräte für den Einsatz in explosionsgefährdeten Bereichen - Teil 1: Grundlagen und Anforderungen / Non-electrical equipment for use in potentially explosive atmospheres - part 1: Basic method and requirements / Appareils non électriques destinés à être utilisés en atmosphères explosives - partie 1 : prescriptions et méthodologie</b>
	<b>DIN EN 13463-5: 2011-10</b>	<b>Nicht-elektrische Geräte für den Einsatz in explosionsgefährdeten Bereichen - Teil 5: Schutz durch konstruktive Sicherheit 'c' / Non-electrical equipment for use in potentially explosive atmospheres - part 5: Protection by constructional safety 'c' / Appareils non électriques destinés à être utilisés en atmosphères explosives - partie 5 : protection par sécurité de construction « c »</b>
<b>X</b>	<b>DIN EN ISO 12100: 2011-03</b>	<b>Sicherheit von Maschinen - Allgemeine Gestaltungsleitsätze Risikobeurteilung und Risikominderung / Safety of machinery - General principles for design / Risk assessment and risk reduction / Sécurité des machines - / Principes généraux pour l'évaluation des risques et la réduction des risques</b>
<b>X</b>	<b>DIN EN ISO 13857: 2008-06</b>	<b>Sicherheit von Maschinen - Sicherheitsabstände gegen das Erreichen von Gefährdungsbereichen mit den oberen und unteren Gliedmaßen / Safety of machinery - Safety distances to prevent hazard zones being reached by upper and lower limbs / Sécurité des machines - Distances de sécurité empêchant les membres supérieurs et inférieurs d'atteindre les zones dangereuses</b>
<b>X</b>	<b>DIN EN 1012-2: 2011-12</b>	<b>Kompressoren und Vakuumpumpen - Sicherheitsanforderungen - Teil 2: Vakuumpumpen / Compressors and vacuum pumps - Safety requirements - part 2: Vacuum pumps / Compresseurs et pompes à vide - Exigences de sécurité - partie 2: pompes à vide</b>
<b>X</b>	<b>DIN EN ISO 2151: 2009-01</b>	<b>Akustik - Geräuschmessnorm für Kompressoren und Vakuumpumpen - Verfahren der Genauigkeitsklasse 2 / Acoustics - Noise test code for compressors and vacuum pumps – Engineering method (grade 2) / Acoustique - norme de mesure des émissions pour les compresseurs et les pompes à vide - Procédé de classe de précision 2</b>
<b>X</b>	<b>DIN EN 60204-1: 2014-10</b>	<b>Sicherheit von Maschinen - Elektrische Ausrüstung von Maschinen - Teil 1: Allgemeine Anforderungen / Safety of machinery - Electrical equipment of machines - part 1: General requirements / Sécurité des machines - Equipement électrique des machines - partie 1: Prescriptions générales</b>
<b>X</b>	<b>EN 61000-6-2: 2011-06</b>	<b>Elektromagnetische Verträglichkeit (EMV) - Teil 6-2: Fachgrundnormen - Störfestigkeit für Industriebereiche / Electromagnetic compatibility (EMC) - part 6-2: Generic standards - Immunity for industrial environments / Compatibilité électromagnétique (EMV) - partie 6-2: Normes génériques - Immunité pour les environnements industriels</b>
<b>X</b>	<b>EN 61000-6-4: 2011-09</b>	<b>Elektromagnetische Verträglichkeit (EMV) - Teil 6-4: Fachgrundnormen - Störaussendung für Industriebereiche / Electromagnetic compatibility (EMC) - part 6-4: Generic standards - Emission standard for industrial environments environments / Compatibilité électromagnétique - partie 6-4: Normes génériques - Emissions de parasites pour les activités industrielles</b>
<b>X</b>	<b>DIN EN 50110-1: 2014-02</b>	<b>Betrieb von elektrischen Anlagen / Operation of electrical installations / Fonctionnement des installations électriques</b>
<b>X</b>	<b>DIN EN 61010-1/A1:2015-04</b>	<b>Sicherheitsbestimmungen für elektrische Mess-, Steuer-, Regel- und Laborgeräte - Teil 1: Allgemeine Anforderungen / Safety requirements for electrical equipment for measurement, control and laboratory use - part 1: General requirements / Consignes de sécurité pour les appareils électriques de mesure, de commande, de régulation ou de laboratoire - partie 1: Prescriptions générales</b>

Bevollmächtigter Vertreter mit Sitz in der Europäischen Gemeinschaft und Person, die befugt ist, die technischen Unterlagen zu erstellen. / Authorized representative established in the European Community and person, who is authorized to compile the technical file. / Représentant autorisé établi dans la Communauté européenne et personne autorisée à établir la documentation technique.

<b>Gardner Denver Thomas GmbH</b> Am Vogelherd 20 98693 Ilmenau / Germany	<b>Datum / Data</b>	<b>2019-01-31</b>
	<b>Baujahr / Year of manufacture / Annee de fabrication</b>	
<b>Werksleiter /</b> Plant manager / <i>Directeur d'usine</i>	<b>Name / Name / Nom</b> <b>Robert Götz</b>	